

EXPLOSION PARTS & LIST

CEN-TEC
systems, inc.

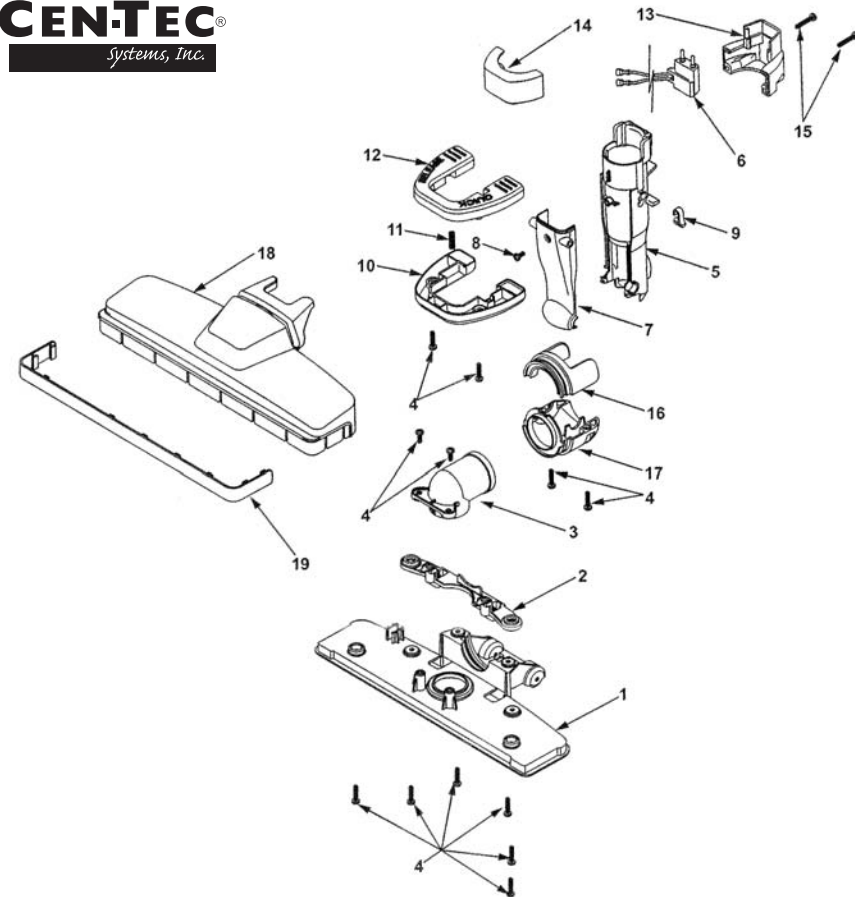

CT-24QD Hard Floor Nozzle

Illustration #	Part #	Part Description	Illustration #	Part #	Part Description
1	56278	Nozzle Brush Unit	11	56388	Pedal Spring
2	56289	Contact Base Unit	12	56399	Foot Pedal Upper
3	56300	Suction Inlet	13	56410	Rear Cover
4	56311	Screw	14	56421	Front Cover
5	56322	Nozzle Support	15	56432	Screw
6	56333	Connection Cord, Swivel	16	56443	Swivel Cap, Floor Nozzle
7	56344	Wire Cover, Front	17	56454	Supporter, Swivel Cap
8	56355	Screw	18	56465	Floor Nozzle Upper
9	56366	Lever, Quick Release	19	56476	Floor Nozzle Bumper
10	56377	Foot Pedal Lower			

1807 Morrissey Drive • Bloomington, IL 61704 / Phone: 309.664.0328 Toll Free: 800.833.2822 / Email: help@centecsystems.com

© Cen-Tec Systems, Inc. 2008 • F51062 10/08



CT-24QD

CT-24QD ELECTRIC BRUSH

SAFETY INSTRUCTIONS

Please read all instructions before using this Electric Powerhead.



Electric shock could occur if used out doors or on wet surfaces.

- 1) Unplug and disconnect power before servicing.
- 2) Always turn off this appliance before connecting or disconnecting either hose or motorized nozzle.
- 3) Do not pick up anything that is burning or smoking, such as cigarettes, matches, or hot ashes.
- 4) Use only as described in this manual. Use only manufacturers recommended attachments.
- 5) Do not unplug by pulling on cord. To unplug, grasp plug, not the cord.
- 6) Do not handle system or appliances with wet hands.
- 7) Turn off all controls before unplugging.
- 8) Do not use with damaged cord or plug. If appliance is not working as it should, has been dropped, damaged, left outdoors, or dropped into water, return it to distributor.
- 9) Do not allow to be used as a toy. Close attention is necessary when used by or near small children.
- 10) The hose contains electrical wires. Do not use if damaged, cut or punctured. Avoid picking up sharp objects.
- 11) Do not put any object into openings.
- 12) Do not use with any opening blocked; keep free of dust, lint, hair, and anything that may reduce air flow.
- 13) Keep hair, loose clothing, fingers, and all parts of the body away from openings and moving parts.
- 14) Do not leave vacuum or brush when plugged in. Unplug from outlet when not in use and before servicing.
- 15) Do not pick up flammable or combustible liquids such as gasoline or use it in areas where they may be present.
- 16) Use extra care when cleaning on stairs.

Save These Instructions.

INTENDED FOR HOUSEHOLD USE ONLY.

2

EXPLOSION PARTS & LIST

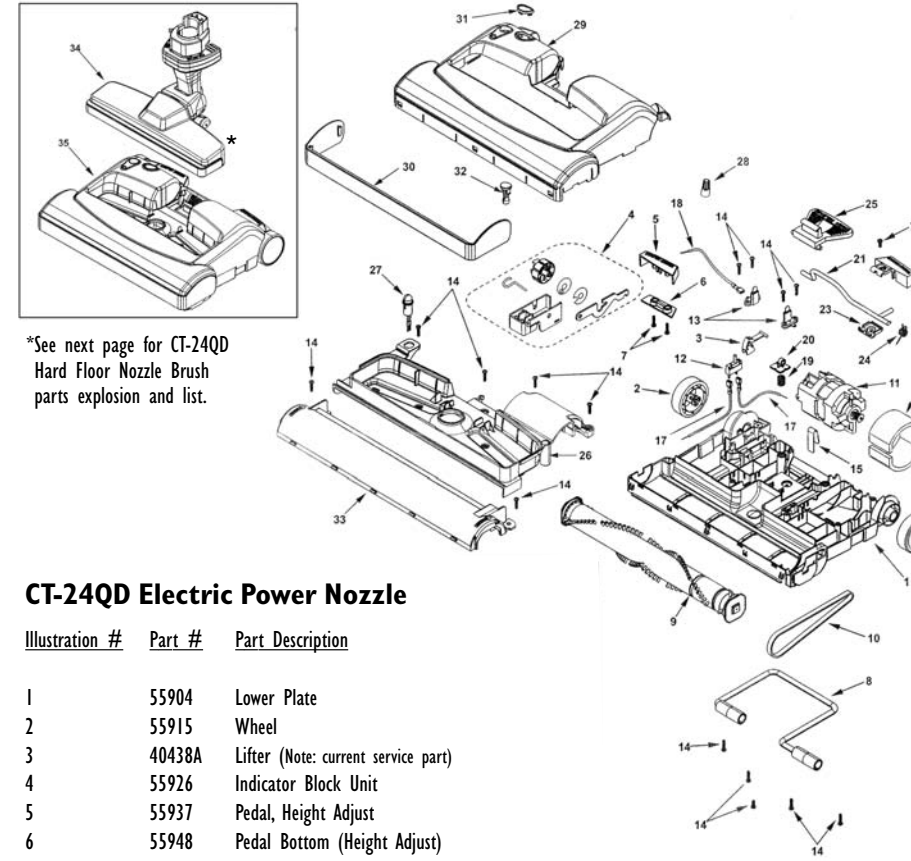

CT-24QD Electric Power Nozzle

Illustration #	Part #	Part Description
1	55904	Lower Plate
2	55915	Wheel
3	40438A	Lifter (Note: current service part)
4	55926	Indicator Block Unit
5	55937	Pedal, Height Adjust
6	55948	Pedal Bottom (Height Adjust)
7	55959	Screw
8	55970	Axle Assembly
9	55981	Agitator Unit
10	55992	Belt
11	56003	Motor
12	56014	Overload Protector
13	56025	Contact Terminal Unit
14	56036	Screw
15	56047	Motor Spring
16	56058	Motor Gasket
17	56069	Lead Wire
18	56080	Lead Wire
19	56091	Spring, Protector
20	56102	Handle Protector
21	56113	Lock, Handle Release
22	56124	Pedal, Handle Release
23	56135	Pedal Fitting, Handle Release
24	56146	Spring, Handle Release

Illustration #	Part #	Part Description
25	56157	Pedal, Brush Release
26	56168	Agitator Cover
27	56179	Bulb Unit (Belt Reset)
28	56190	Wire Connector
29	56201	Nozzle Housing
30	56212	Furniture Guard
31	56223	Window (Height Adjust)
32	56234	Button, Belt Reset
33	56245	Agitator Cover
34	56256	Floor Nozzle Brush Assembly*
35	56267	Power Nozzle Assembly*

*Note: Floor Nozzle Brush and Power Nozzle are optional if Cen-Tec needs to service as a one piece unit

7

AGITATOR SERVICING



WARNING

Electrical Shock or Personal Injury Hazard
Disconnect electrical supply before servicing or cleaning the unit. Failure to do so could result in electrical shock or personal injury from cleaner suddenly starting.

To Check Agitator Assembly:

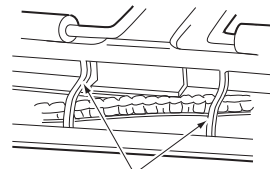

Base Support Bars

When brushes are worn to the level of the base support bars, replace the agitator assembly.

To Replace Agitator Assembly:

- 1) Remove the POWERHEAD cover, belt and agitator assembly. See "To Remove Belt" in BELT CHANGING AND AGITATOR CLEANING.
- 2) Reinstall belt, new agitator assembly, and POWERHEAD cover. See "To Replace Belt" in BELT CHANGING AND AGITATOR CLEANING.

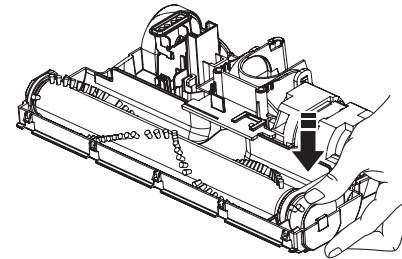

LIGHT BULB CHANGING

- 1) Remove the POWERHEAD cover as shown in BELT CHANGING AND AGITATOR CLEANING section.

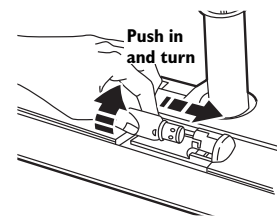

Push in and turn

- 2) Push in and turn bulb counterclockwise, then pull out to remove.

- 3) Push in and turn the bulb clockwise, to replace. Bulb must not be higher than 130 volts/15 Watts.

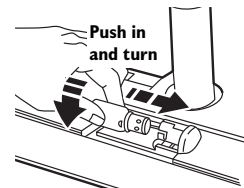

Push in and turn

- 4) Reinstall the POWERHEAD cover as shown in BELT CHANGING AND AGITATOR CLEANING section.

PILE HEIGHT SETTINGS

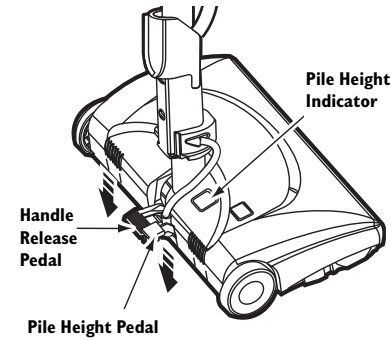

Pile Height Indicator

Handle Release Pedal

Pile Height Pedal

Suggested pile height settings:

For best deep down cleaning, use the **XLO** setting. However you may need to raise the height to make some jobs easier, such as scatter rugs and some deep pile carpets, and to prevent the vacuum cleaner from shutting off.

As a general guide:

XLO — most carpet heights **MED** — medium to long pile
LO — short to medium pile **HI** — shag and long pile

ELECTRIC BRUSH CARE

Always follow all safety precautions when cleaning and servicing the POWERHEAD.



WARNING

Electrical Shock or Personal Injury Hazard
Disconnect electrical supply before servicing or cleaning the unit. Failure to do so could result in electrical shock or personal injury from cleaner suddenly starting.

Belt Changing and Agitator Cleaning

Disconnect cleaner from electrical outlet. Frequently check and remove hair, string and lint buildup in brush area. If buildup becomes excessive, disconnect the brush from wand and follow steps below.

To Remove Belt:

- 1) Turn the POWERHEAD upside down.
- 2) Unscrew the brush cover screws.

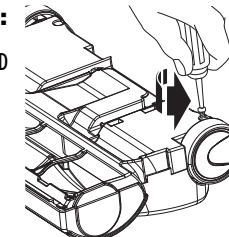

- 3) Turn the POWERHEAD right side up. Press handle release pedal and lower the swivel. To remove cover, grasp the sides and pull out to release the outside of the cover.

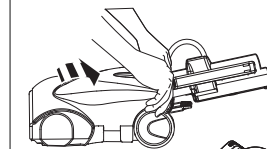
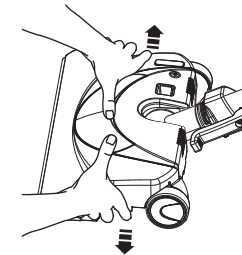

- 4) Lift rear latches up and tilt cover forward from back until front snaps free.

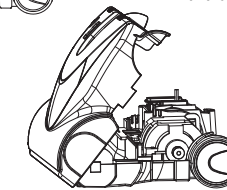

- 5) Lift agitator assembly out, remove worn belt and clear any hair, string or lint build-up from brush area.

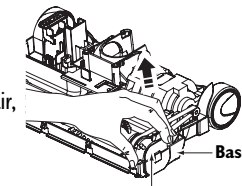

Base

End Cap

ELECTRIC BRUSH CARE

To Replace Belt:

- 1) Install new belt over motor drive, then over brush sprocket.

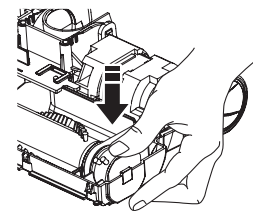
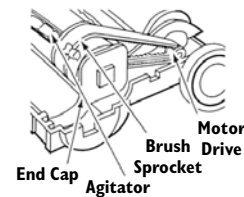

- 2) Replace agitator assembly back into the POWERHEAD.

- 3) Line up front of cover and base. Rest cover on front edge of base as shown.

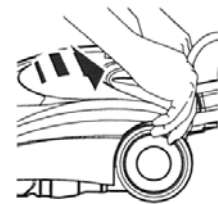
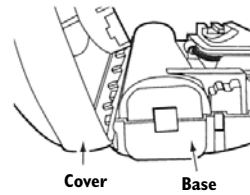

- 5) Tilt cover to back. Press cover firmly until side and rear tabs snap into place. Turn the POWERHEAD upside down and replace the 2 cover screws.

LIFT OFF HARD FLOOR BRUSH

REMOVAL OF THE HARD FLOOR BRUSH

NOTE: Make sure you have turned off the power supplied to the electric brush nozzle by using the on-off switch found on the handle.

- (1) Using your foot simply depress the tab located on the rear of the electric brush that reads "Brush Release".
- (2) While keeping the tab depressed lift the wand in an upwards motion.
- (3) This will disengage the hard floor brush from the electric nozzle.

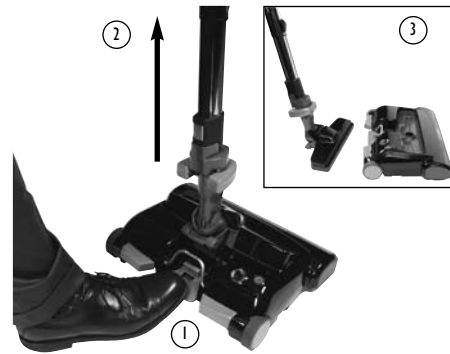

RE-INSTALLING THE HARD FLOOR BRUSH

Note: Make sure the on-off switch located in the handle is still in the "OFF" position.

- (1) Insert the front edge of the hard floor brush into the electric brush nozzle.
- (2) Using the wand, gently press down on the tool you will hear it snap into place.
- (3) You are now ready to use the electric brush nozzle.

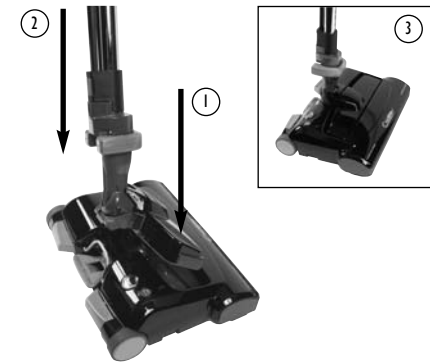

SPECIAL FEATURES

Edge Cleaner

Active brush edge cleaners are on both sides of the POWERHEAD electric brush. Guide either side of the brush along baseboards or next to furniture to help remove dirt trapped at carpet edges.

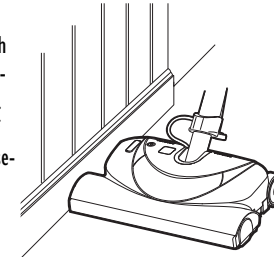

Overload Protector

The overload protector protects the motor from brush jamming and belt breakage. If the agitator slows down or stops, the overload protector shuts off the brush.

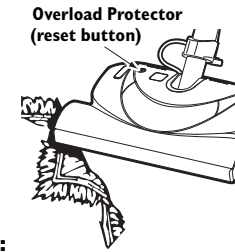

To correct problem:

Unplug the electrical cord, remove obstruction. Check brush area for excessive lint buildup or jamming.

To reset:

Press the reset button on top of the brush. Plug in the power cord, turn on vacuum and brush.

WANDS & ATTACHMENTS

Telescoping Wand

The wand length is adjustable and requires no assembly. To adjust, simply push down on the wand adjust button and slide the upper wand to the desired height.

The swivel, located on the POWERHEAD allows you to turn the handle to the left side to reach farther under low furniture.

When raising the wand you may have to hold the POWERHEAD with your hand or foot.

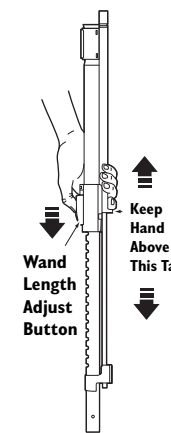
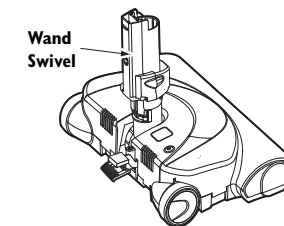

Wand Attachment

1. To remove wand from the POWERHEAD, lock wands in straight-up position.

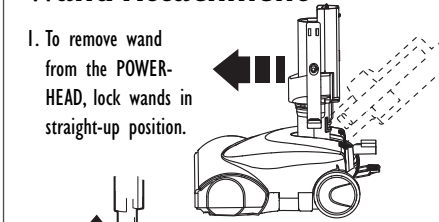

2. Press wand easy release pedal with foot and pull the wands straight up out of the POWERHEAD. The plug and cord do not have to be removed to use attachments on the wands.

